



WELL Communications



# Siena & Aris Hospital

by Haelvoet

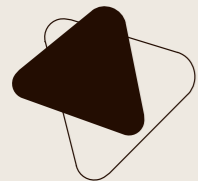

HAEVOET NV **BELGIUM**  
L. BEKAERTSTRAAT 8, 8770 INGELMUNSTER  
T +32 (0) 51 48 66 95 F +32 (0) 51 48 73 19  
INFO@HAEVOET.BE WWW.HAEVOET.BE

HOSPITAL - NURSING HOME FURNITURE

# Siena

The Siena hospital bed combines user-friendliness with a highly functional and efficient mattress platform.



001	<b>Sideguards (*) • Safety has no price</b>
	The Atmosphère sideguards protect the patient over 2/3 of the bed length. The Trix sideguards can be chosen as well. These can be telescopically extended and offer maximum patient protection over the entire bed length.
002	<b>Mattress platform • For a comfortable lying position</b>
	You can choose between 2 different mattress platforms. The standard version is equipped with well-ventilating metal mattress platform profiles. The optional solid laminate mattress platform sections (*) can be easily removed and cleaned.
003	<b>Bed panels • A harmonious duo</b>
	You can choose between 4 different bed panel types: Vela, Lauro (*), Jaro (*) and the wooden bed panel Senzo (*). All types can be easily removed without needing any tools.
004	<b>Mattress holders • Purposefully present</b>
	The mattress holders prevent the mattress from moving towards the bed sides. They can also be used as a handle to adjust the backrest and knee rest manually.
005	<b>Cases • Optimal care</b>
	Two cases are provided at both the head and the foot of the bed, and can be used to install an IV rod, a lifting pole or other accessories.
006	<b>Operating lever • Central and within reach</b>
	The operating lever activates a gas spring, so that the desired mattress platform section can be adjusted. Optionally, the backrest and legrest adjustments can be activated electrically (*). It is also possible to switch off the electric functions with one single button on the lock device (*).
007	<b>Accessory holders • First-class functionality</b>
	Three multifunctional holders on both sides make it possible to install accessories very fast and easily.
008	<b>Bed extension • Increased flexibility</b>
	The standard integrated bed extension makes it possible to extend the bed with 20 cm. The optional footrest extension (*) guarantees a complete functionality of the mattress platform.
009	<b>Castors (*) • Superb manoeuvrability</b>
	Our extensive gamut of high-quality design castors guarantees a highly mobile and manoeuvrable bed.
010	<b>Central brake (*) • Activated with one single movement</b>
	The castors are equipped with a central brake mechanism. Thanks to the accessible brake pedal, the Siena bed simplifies patient treatments by the nursing staff considerably.

## Comfort for everyone

The bed can be used very easily and efficiently, which simplifies the daily work of the nursing staff considerably.

### • Activations

The operating lever is user-friendly and easy to activate on both sides of the bed.

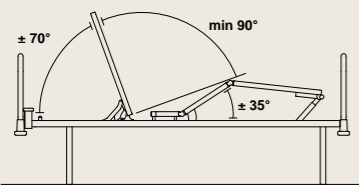
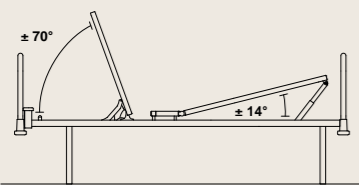

#### Seating or relax position

The three- or four-section (\*) mattress platform offers ample adjustment possibilities and can be easily activated on both sides of the bed. Thanks to this, the desired seating position – or relax position (\*) in case of a four-section mattress platform – can be easily obtained. Optionally, the backrest and legrest adjustments can be activated electrically by means of a hand switch.

#### Trendelenburg position

The Trendelenburg position (\*) can be activated by means of the red pedal at the foot of the bed. When the pedal is stepped on, the bed inclines fluently until the desired position is obtained.

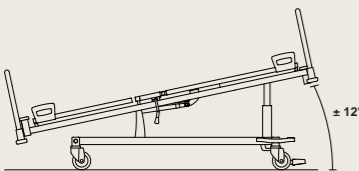

### • Retracting backrest

A retracting backrest increases the patient's lying comfort considerably. While inclining the backrest upwards, it is automatically moved towards the head end. By doing so, pressure is relieved on the pelvis, whereas the bedsore risk is reduced substantially.



001



002



003



004

### • High/low carriage

The high/low carriage Vico (\*) can be installed very easily to obtain a complete high/low bed. Combined with the removable synthetic cover cap (\*), even the surfaces that are difficult to reach can be cleaned easily.

## User-friendly

Particular attention has been paid to efficient care during the development of the Siena bed.

### • Castors - Excellent mobility

The daily use of the Siena bed is simplified, thanks to its excellent mobility and manoeuvrability. You can choose from our extensive gamut of castors (Ø 100 mm or Ø 125 mm) with or without central brakes (\*).



standard on fixed legs or height-adjustable (\*) legs



castors Ø 100 mm with individual brakes, optionally height-adjustable (\*)

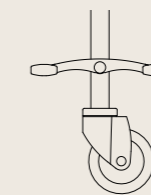

castors Ø 125 mm with central brake and directional castor (\*)

The directional castor makes it easier to move the bed in a straight line.

### • Bed extension - Flexibility

A hospital bed has to meet everyone's needs, irrespective of the patient's length. The integrated bed extension makes it possible to extend the bed with 20 cm. An optional footrest extension (\*) guarantees the full functionality of the mattress platform.

### • Mechanical - High usability

The Siena Hospital bed is completely mechanical, which makes sure that this bed can be used everywhere and in all situations. An electric version is optionally available as well.

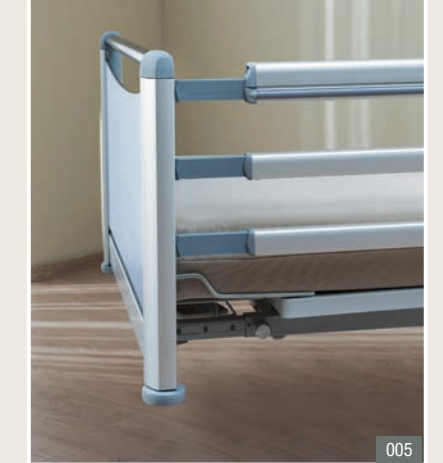

005

## Safety galore

Our sideguard types offer complete patient safety in each bed position. Each type has its specific advantages for both the user and patient.



The Atmosphère sideguards (\*) constitute one unit and can be lowered by means of an easy locking mechanism.



The Trix sideguards (\*) consist of 3 siderails, offering maximum patient safety over the entire bed length. An integrated telescopic extension makes sure that the Trix sideguards cover the bed sides over the entire length, even when the bed is extended.

001 The Siena Hospital bed with castors (\*).

002 The operating lever.

003 The Trendelenburg pedal (\*).

004 The retracting backrest.

005 Extended bed with the telescopically extendable Trix sideguards (\*).

\* option for Siena Hospital

# Siena Hospital Summary

## • Dimensions and performances (standard bed)

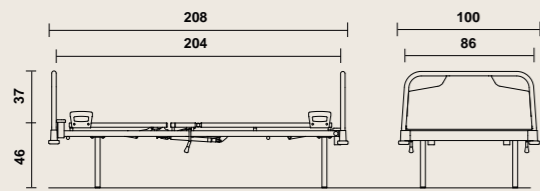

- length: 208 cm, width: 100 cm;
- height of the mattress platform: ± 46 cm, optionally adjustable up to ± 55 cm (in 3 positions);
- safe working load: 180 kg;
- weight (without accessories): 65 kg;
- mattress platform dimensions: 204 x 86 cm;
- mattress dimensions: 195 x 85 cm, thickness: 12 to 16 cm (\*).

\* The mattress thickness depends on the sideguards type



Haelvoet makes sure that its excellent price-quality ratio is not at the expense of the environment. Our company considers durability – in all possible meanings – of paramount importance. All our products have a long lifespan and are delivered with a 10-year-guarantee on construction errors.









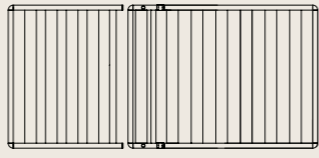
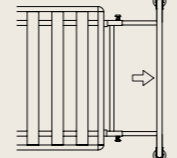
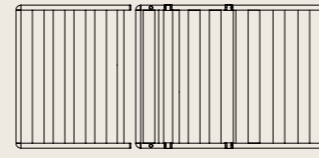
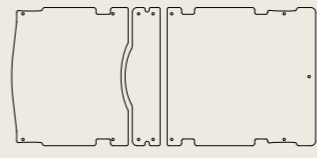
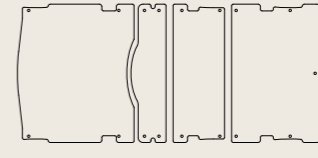
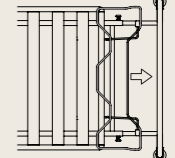

The Siena hospital bed is made in accordance with ISO 9001:2015 and ISO 13485:2016 and complies with the European Medical Device Regulation EU 2017/745 and all other applicable European harmonised norms:

EN 60601-1 Medical electrical equipment - Part 1: General requirements for basic safety and essential performance.

EN 60601-1-2 Medical electrical equipment - Part 1-2: General requirements for safety and essential performance - Secondary norm: Electromagnetic compatibility - Requirements and tests.

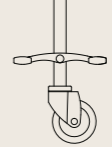
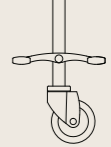
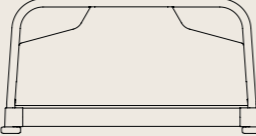
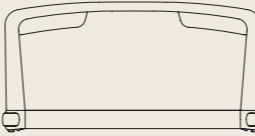
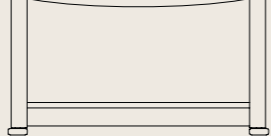
EN 60601-2-52 Medical electrical equipment - Part 2-52: Particular requirements for the basic safety and essential performance of medical beds.

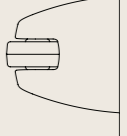
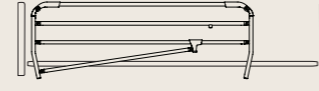
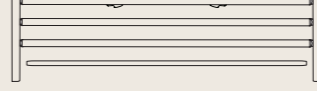
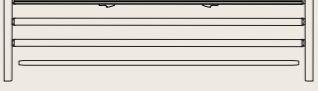
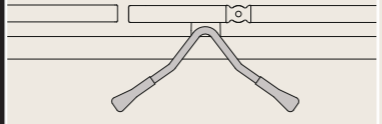
EN ISO 14971 Application of risk management to medical devices.

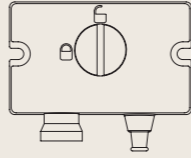
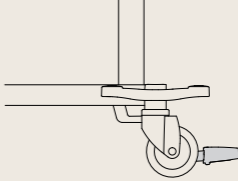
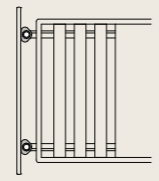
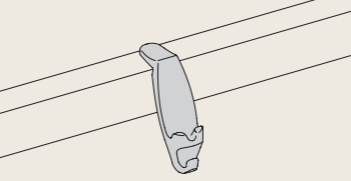
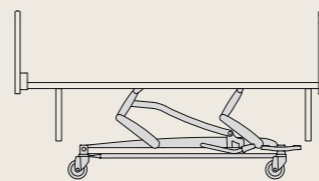
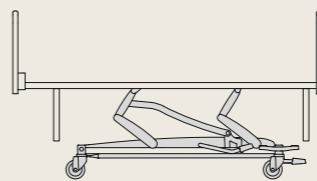
	Standard Siena		Options Siena				
MATRESS PLATFORM	 • 3-section steel mattress platform	 • Telescopic bed extension up to 20 cm	 • 4-section steel mattress platform	 • 3-section mattress platform with removable solid laminate sections	 • 4-section mattress platform with removable solid laminate sections	 • Footrest extension up to 20 cm	
CASTORS	 • Legs, fixed height		 • Adjustable legs in 3 positions	 • Non-adjustable legs, castors ø 100 mm, individual brakes	 • Adjustable legs, castors ø 100 mm, individual brakes	 • Non-adjustable legs, castors ø 125 mm, central brakes	 • Non-adjustable legs, castors ø 125 mm, directional castor, central brakes
PANELTYPE	 • Vela panel		 • Lauro panel	 • Jaro panel	 • Senzo panel	 • Wall spacer	
SIDEGUARDS			 • Atmosphère sideguards	 • Trix sideguards (only in combination with Jaro panel)	 • Trix sideguards with 4th rail (only in combination with Jaro panel)		
CONTROLS	 • Operating lever		 • Electric hand switch	 • Lock device (ACL)	 • Trendelenburg pedal (fixed height)		
EXTRAS	 • 4 cases (head and foot of the bed)	 • 6 synthetic accessory hooks	 • High/low carriage Vico	 • High/low carriage Vico with Trendelenburg pedal			



# Aris

The Aris hospital bed is an efficient and comfortable metal bed. The optional inclinable backrest can be operated simply on both sides of the bed.

001	<b>Sideguards (*)</b> • Safety has no price
	The Atmosphère sideguards protect the patient over 2/3 of the bed length.
002	<b>Bed panels</b> • Stylish and durable
	The standard low panel frames have a timeless look. The bed can be optionally equipped with high panels with solid laminate inserts (*).
003	<b>Cases</b> • Optimal care (only with a two-section mattress platform)
	Two cases at the head of the bed can be used to install an IV rod, a lifting pole or other accessories. Thanks to this, the bed can meet specific needs.
004	<b>Operating lever (*)</b> • Central and within reach (only with a two-section mattress platform)
	The operating lever on both sides activates a gas spring, which makes it easy to adjust the backrest in the desired position.
005	<b>Mattress platform</b> • For a comfortable lying position
	The mattress platform is equipped with well-ventilating metal mattress platform profiles.
006	<b>Castors (*)</b> • Superb manoeuvrability
	The Aris hospital bed can be optionally equipped with castors Ø 100 mm with individual brakes.



**001** The standard Aris Hospital bed with a 1-section mattress platform and low panel frames.

\* option for Aris Hospital

# Aris Hospital Summary

## • Dimensions

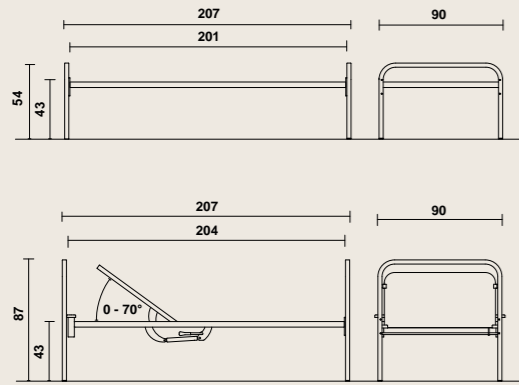

- length: 207 cm, width: 90 cm;
- height of the mattress platform: ± 43 cm;
- weight (without accessories): 43 kg;
- mattress platform dimensions: 201 x 90 cm (standard bed);
- mattress platform dimensions: 204 x 90 cm (2-section mattress platform);
- mattress dimensions: 195 x 90 cm, thickness: 12 to 15 cm.



Haelvoet makes sure that its excellent price-quality ratio is not at the expense of the environment. Our company considers durability – in all possible meanings – of paramount importance. All our products have a long lifespan and are delivered with a 10-year-guarantee on construction errors.





The Aris hospital bed is made in accordance with SO 9001:2015 and ISO 13485:2016 and complies with the European Medical Device Regulation EU 2017/745 and all other applicable European harmonised norms:

EN 60601-1 Medical electrical equipment - Part 1: General requirements for safety, except for the electrical clauses.

EN 60601-2-52 Medical electrical equipment - Part 2-52: Particular requirements for the basic safety and essential performance of medical beds, except for the electrical clauses.

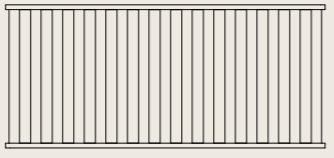
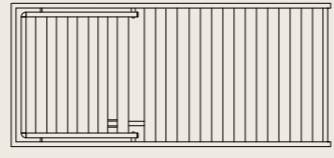
EN ISO 14971 Application of risk management to medical devices.

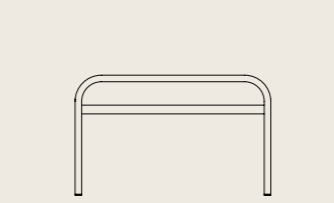
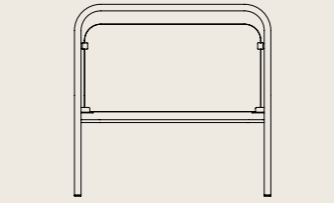
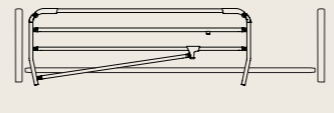
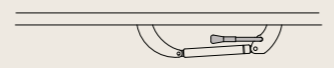
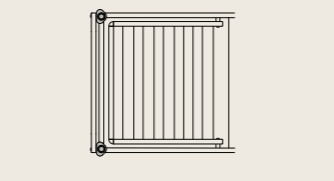
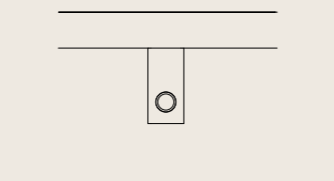
	Standard Aris	Options Aris
MATTRESS PLATFORM	 <ul style="list-style-type: none"> <li>• 1-section steel mattress platform</li> </ul>	 <ul style="list-style-type: none"> <li>• 2-section steel mattress platform</li> </ul>
CASTORS	 <ul style="list-style-type: none"> <li>• Legs with synthetic glides</li> </ul>	 <ul style="list-style-type: none"> <li>• Castors ø 100 mm, individual brakes</li> </ul>
PANELTYPE	 <ul style="list-style-type: none"> <li>• Low panel frame</li> </ul>	 <ul style="list-style-type: none"> <li>• High panel frame with solid laminate insert panel</li> </ul>
SIDEGUARDS		 <ul style="list-style-type: none"> <li>• Atmosphère sideguards (only with high panel frame)</li> </ul>
CONTROLS	 <ul style="list-style-type: none"> <li>• Operating lever (only with a 2-section mattress platform)</li> </ul>	
EXTRAS	 <ul style="list-style-type: none"> <li>• 2 cases at the head of the bed (only with a 2-section mattress platform)</li> </ul>	 <ul style="list-style-type: none"> <li>• Cases for Atmosphère sideguards</li> </ul>

## Accessories

The accessories we offer can be harmoniously connected with the existing cases and accessory holders. Haelvoet strongly pays attention to this, so that the accessories offer you the same top quality as our hospital beds. After all, only the best products are good enough for our customers.

<p>001 Lifting pole</p>  <p>The lifting pole is made of a bent thick-walled steel tube. It is equipped with a handle and a ribbon that can be manually adjusted. An automatic roll-up system is optionally available as well.</p>	<p>006 IV rod</p>  <p>The IV rod consists of a fixed and a height-adjustable part that is equipped with 4 hooks. The IV rod is also available in a non-adjustable version with 2 hooks.</p>
<p>002 IV holder for lifting pole</p>  <p>The IV holder for the lifting pole consists of 4 hooks and can be easily installed on the lifting pole.</p>	<p>007 Raising aid (*)</p>  <p>The ergonomically-designed raising aid offers optimal patient support while getting in and out of the bed.</p>
<p>003 Name card holder (*)</p>  <p>The name card holder can be put on the bed panel. This accessory enables you to identify the patient very fast and easily.</p>	<p>008 Urine bottle holder (*)</p>  <p>The urine bottle holder is installed in two standard synthetic accessory hooks. You can choose between two different models.</p>
<p>004 Accessory bracket (*)</p>  <p>The accessory bracket can be used in case of specific customer needs. The bracket is equipped with 4 hooks and has a length of 310 mm. It is put in the accessory hooks.</p>	<p>009 Bed pan holder (*)</p>  <p>The bed pan holder can be easily attached to the bed panel.</p>
<p>005 Bowl holder (*)</p>  <p>Two bowls can be placed into the bowl holder. The holder is installed in the accessory hooks.</p>	<p>010 Oxygen bottle holder</p>  <p>The oxygen bottle holder consists of a strong arm and a basket made of solid steel wire. It is finished with a chromium layer.</p>
	<p>011 Removable footrest extension (*)</p>  <p>To use the mattress platform optimally when the bed is extended, you can opt for a removable footrest extension of 20 cm that has to be put at the foot end.</p>

\* only possible for Siena Hospital.